

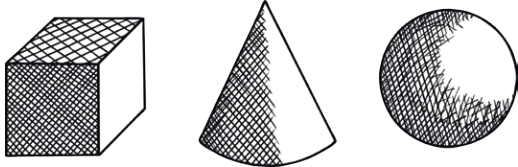

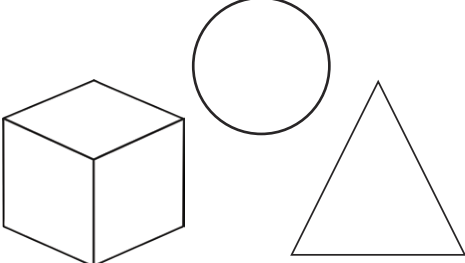



Tonal Shading

Your task today is to develop your tonal shading skills using the techniques of cross-hatching, blending, stippling, contour-hatching and scumbling.

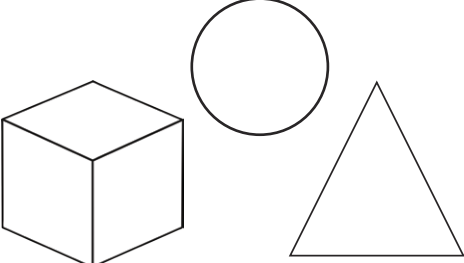
Using pencil, apply these techniques to the series of basic shapes and forms below.

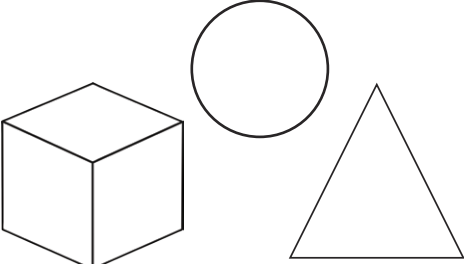
Technique	Example	
Cross-Hatching		
Blending		
Stippling		
Contour-Hatching		
Scumbling		

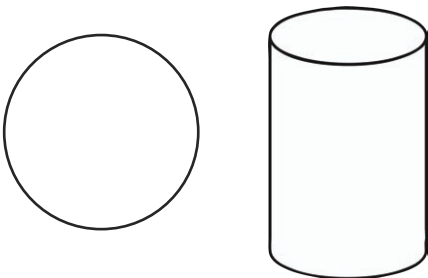
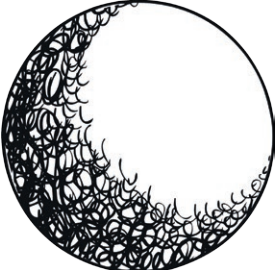
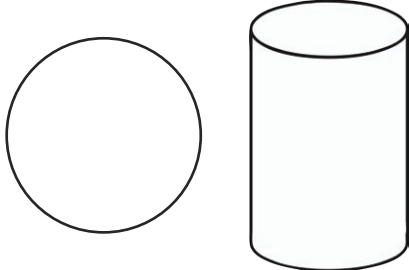
Extension Task

Using one or more of the tonal drawing techniques, apply these to the composition below:

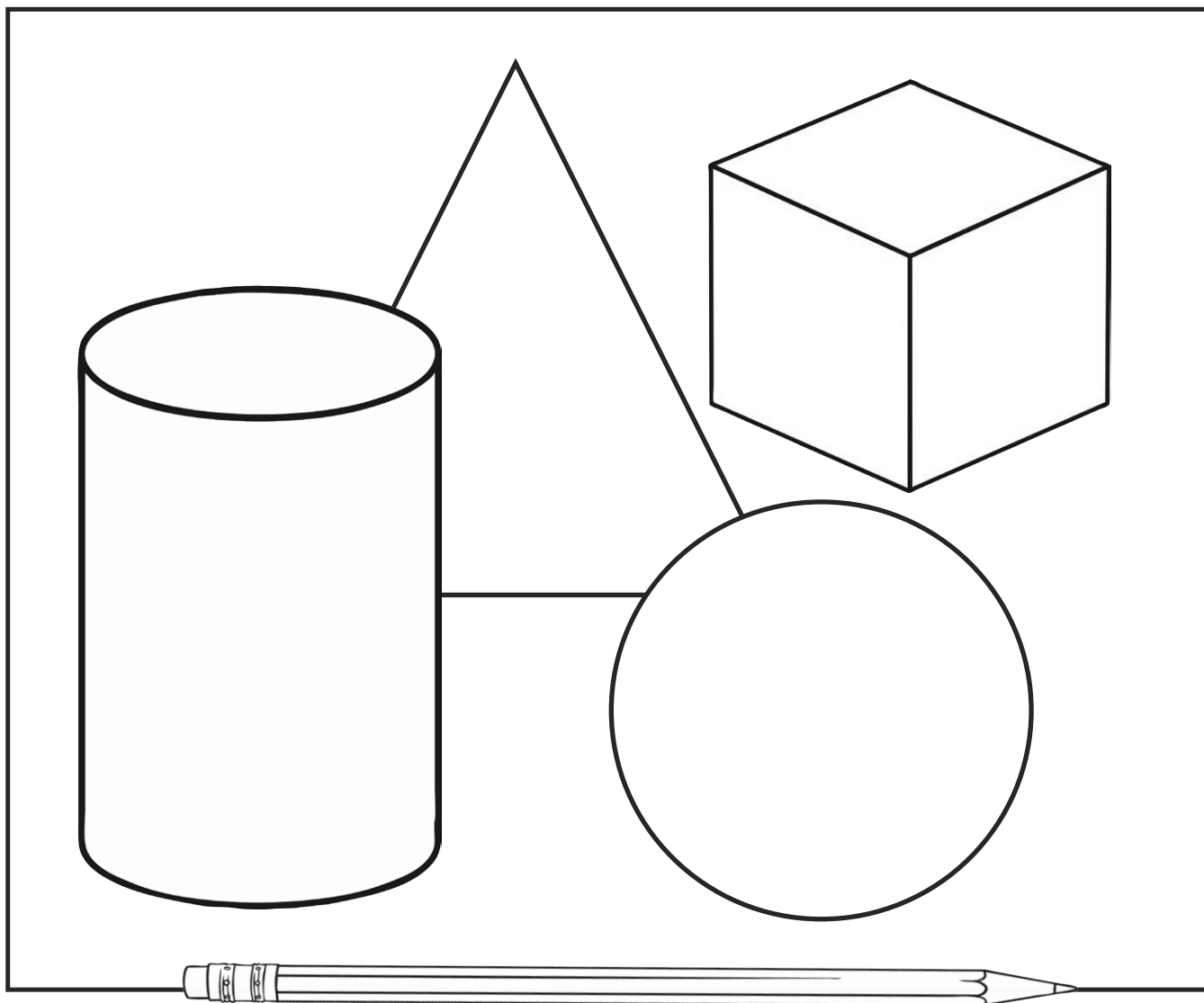

Peer Assessment

Swap your tonal shading activity sheet with your partner for a peer assessment task.

Thinking about the success criteria below, give your partner two positive comments about their work and one thing they could improve upon.

- To create light, medium and dark tones with pencil.
- To experiment with cross-hatching, blending and stippling.
- To apply these techniques to make an object appear 3D.

• _____

• _____

You can improve your work by _____
